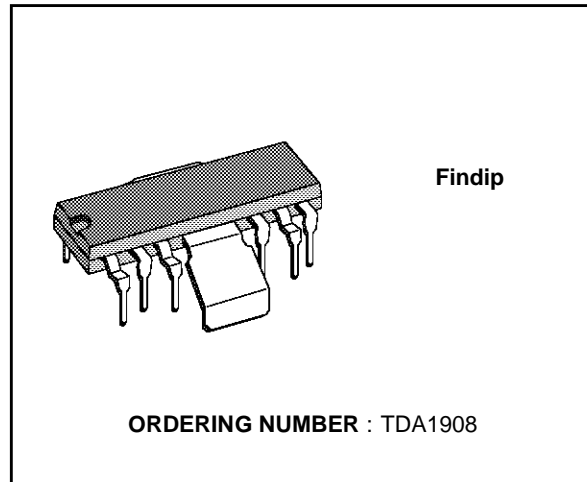


**8W AUDIO AMPLIFIER**

**DESCRIPTION**

The TDA1908 is a monolithic integrated circuit in 12 lead quad in-line plastic package intended for low frequency power applications. The mounting is compatible with the old types TBA800, TBA810S, TCA830S and TCA940N. Its main features are:

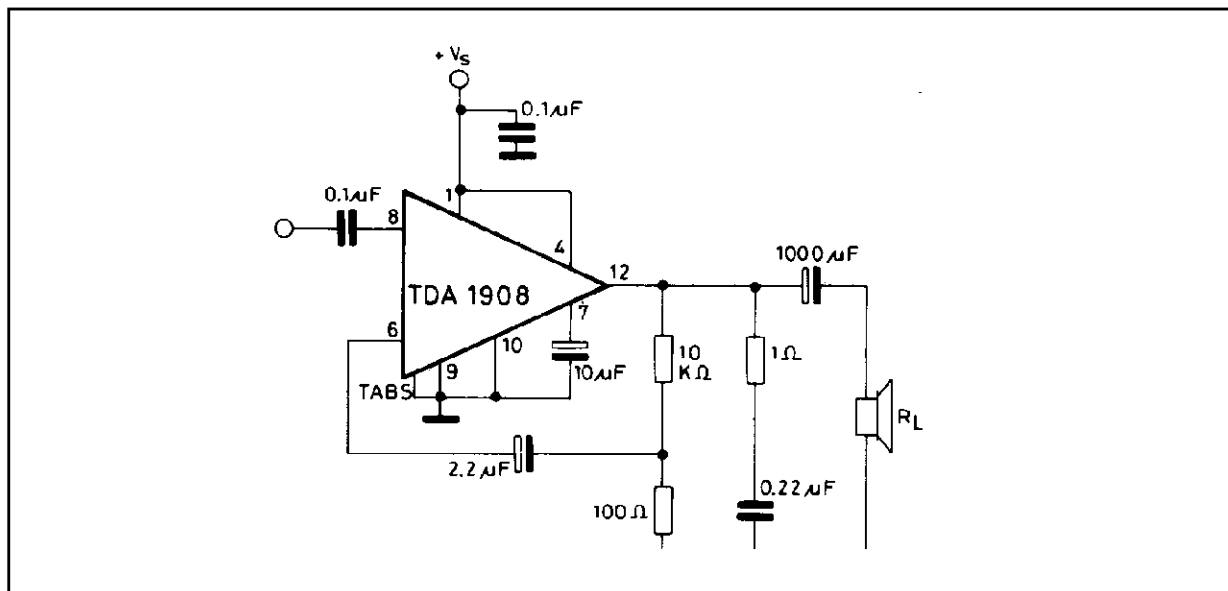
- flexibility in use with a max output current of 3A and an operating supply voltage range of 4V to 30V;
- protection against chip overtemperature;
- soft limiting in saturation conditions;
- low "switch-on" noise;
- low number of external components;
- high supply voltage rejection;
- very low noise.



**ABSOLUTE MAXIMUM RATINGS**

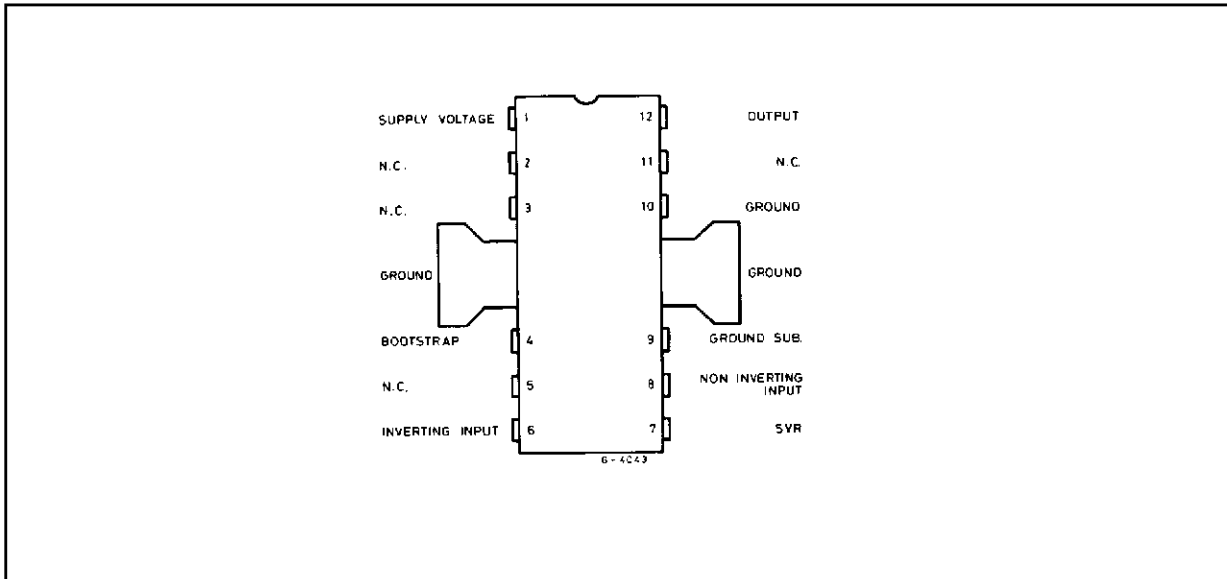
Symbol	Parameter	Value	Unit
$V_s$	Supply voltage	30	V
$I_o$	Output peak current (non repetitive)	3.5	A
$I_o$	Output peak current (repetitive)	3	A
$P_{tot}$	Power dissipation: at $T_{amb} = 80^\circ C$	1	W
	at $T_{amb} = 90^\circ C$	5	W
$T_{stg}, T_j$	Storage and junction temperature	-40 to 150	$^\circ C$

**APPLICATION CIRCUIT**

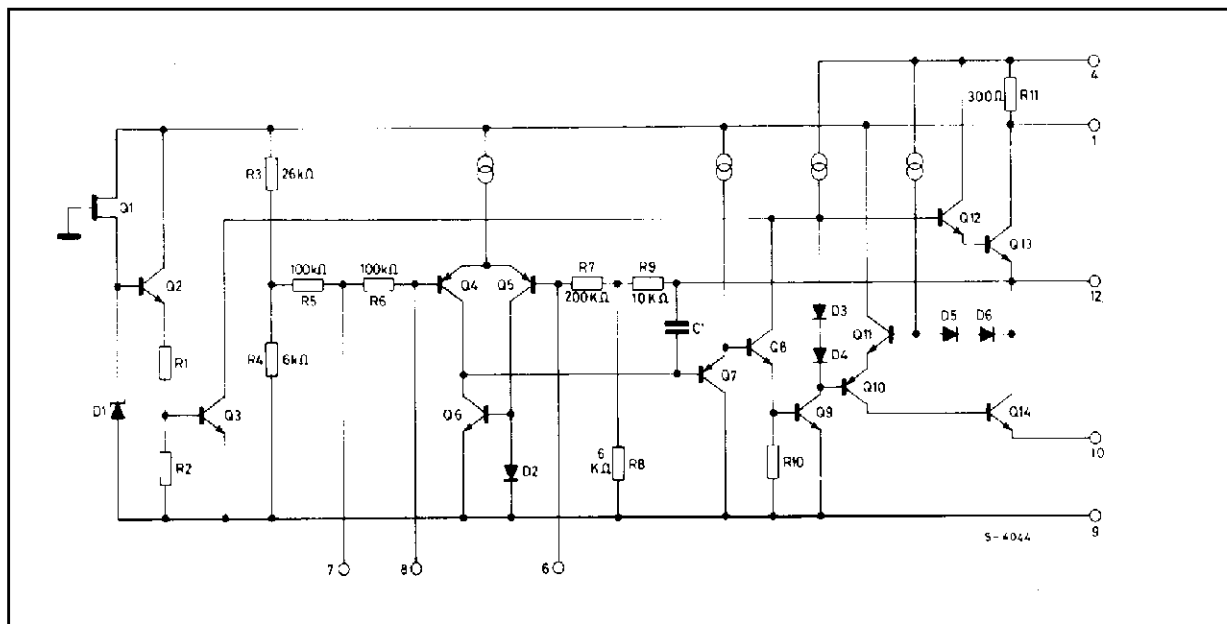


# TDA1908

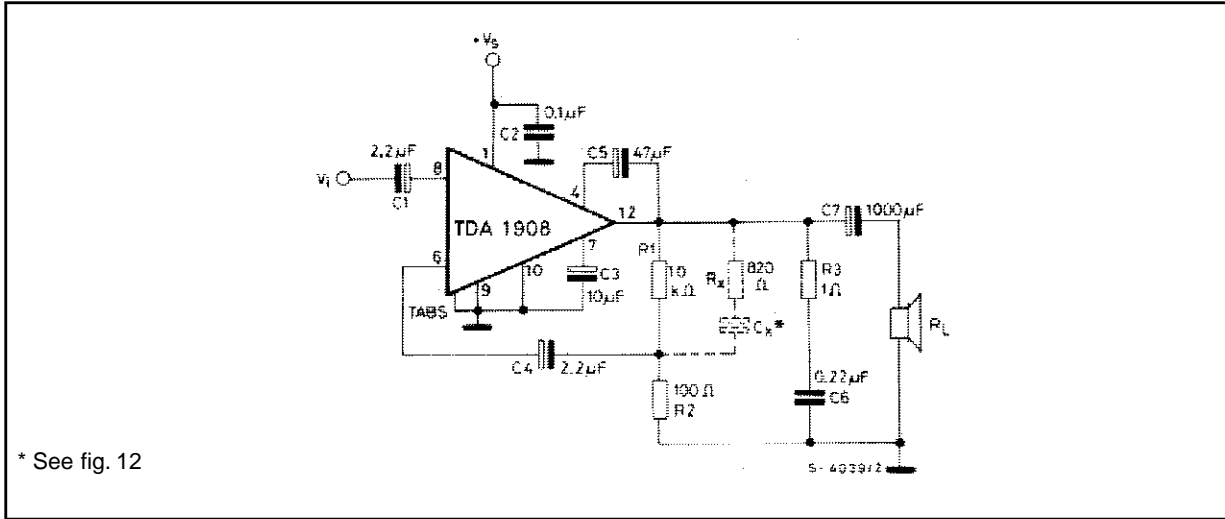
## PIN CONNECTION (top view)



## SCHEMATIC DIAGRAM



TEST CIRCUIT



THERMAL DATA

Symbol	Parameter	Value	Unit
$R_{th\ j-tab}$	Thermal resistance junction-tab	max 12	°C/W
$R_{th\ j-amb}$	Thermal resistance junction-ambient	max (°) 70	°C/W

(°) Obtained with tabs soldered to printed circuit board with min copper area.

ELECTRICAL CHARACTERISTICS (Refer to the test circuit,  $T_{amb} = 25\text{ }^{\circ}\text{C}$ ,  $R_{th}$  (heatsink) =  $8\text{ }^{\circ}\text{C/W}$ , unless otherwise specified)

Symbol	Parameter	Test conditions	Min.	Typ.	Max.	Unit
$V_s$	Supply voltage		4		30	V
$V_o$	Quiescent output voltage	$V_s = 4V$ $V_s = 18V$ $V_s = 30V$	1.6 8.2 14.4	2.1 9.2 15.5	2.5 10.2 16.8	V
$I_d$	Quiescent drain current	$V_s = 4V$ $V_s = 18V$ $V_s = 30V$		15 17.5 21	35	mA
$V_{CEsat}$	Output stage saturation voltage (each output transistor)	$I_c = 1A$ $I_c = 2.5A$		0.5 1.3		V
$P_o$	Output power	$d = 10\%$ $f = 1KHz$ $V_s = 9V$ $R_L = 4\Omega$ $V_s = 14V$ $R_L = 4\Omega$ $V_s = 18V$ $R_L = 4\Omega$ $V_s = 22V$ $R_L = 8\Omega$ $V_s = 24V$ $R_L = 16\Omega$	7 6.5 4.5	2.5 5.5 9 8 5.3		W

**ELECTRICAL CHARACTERISTICS** (continued)

Symbol	Parameter	Test conditions	Min.	Typ.	Max.	Unit
d	Harmonic distortion	f = 1KHz V <sub>s</sub> = 9V R <sub>L</sub> = 4Ω P <sub>o</sub> = 50 mW to 1.5 W V <sub>s</sub> = 18V R <sub>L</sub> = 4Ω P <sub>o</sub> = 50 mW to 4W V <sub>s</sub> = 24V R <sub>L</sub> = 16Ω P <sub>o</sub> = 50 mW to 3W		0.1 0.1 0.1		%
V <sub>i</sub>	Input sensitivity	V <sub>s</sub> = 9V R <sub>L</sub> = 4Ω P <sub>o</sub> = 2.5W V <sub>s</sub> = 14V R <sub>L</sub> = 4Ω P <sub>o</sub> = 5.5W V <sub>s</sub> = 18V R <sub>L</sub> = 4Ω P <sub>o</sub> = 9W V <sub>s</sub> = 22V R <sub>L</sub> = 8Ω P <sub>o</sub> = 8W V <sub>s</sub> = 24V R <sub>L</sub> = 16Ω P <sub>o</sub> = 5.3W		37 52 64 90 110		mV
V <sub>i</sub>	Input saturation voltage (rms)	V <sub>s</sub> = 9V V <sub>s</sub> = 14V V <sub>s</sub> = 18V V <sub>s</sub> = 24V	0.8 1.3 1.8 2.4			V
R <sub>i</sub>	Input resistance (pin 8)	f = 1 KHz	60	100		KΩ
I <sub>s</sub>	Drain current	f = 1 KHz V <sub>s</sub> = 14V R <sub>L</sub> = 4Ω P <sub>o</sub> = 5.5W V <sub>s</sub> = 18V R <sub>L</sub> = 4Ω P <sub>o</sub> = 9W V <sub>s</sub> = 22V R <sub>L</sub> = 8Ω P <sub>o</sub> = 8W V <sub>s</sub> = 24V R <sub>L</sub> = 16Ω P <sub>o</sub> = 5.3W		570 730 500 310		mA
η	Efficiency	V <sub>s</sub> = 18V f = 1 KHz R <sub>L</sub> = 4Ω P <sub>o</sub> = 9W		72		%
BW	Small signal bandwidth (-3 dB)	V <sub>s</sub> = 18V R <sub>L</sub> = 4Ω P <sub>o</sub> = 1W	40 to 40 000			Hz
G <sub>v</sub>	Voltage gain (open loop)	f = 1 KHz		75		dB
G <sub>v</sub>	Voltage gain (closed loop)	V <sub>s</sub> = 18V R <sub>L</sub> = 4Ω f = 1 KHz P <sub>o</sub> = 1W	39.5	40	40.5	dB
e <sub>N</sub>	Total input noise	(°) R <sub>g</sub> = 50Ω R <sub>g</sub> = 1KΩ R <sub>g</sub> = 10KΩ		1.2 1.3 1.5	4.0	μV
		(°°) R <sub>g</sub> = 50Ω R <sub>g</sub> = 1KΩ R <sub>g</sub> = 10KΩ		2.0 2.0 2.2	6.0	μV
S/N	Signal to noise ratio	V <sub>s</sub> = 18V R <sub>g</sub> = 10KΩ (°) P <sub>o</sub> = 9W R <sub>g</sub> = 0 R <sub>L</sub> = 4Ω		92 94		dB
		R <sub>g</sub> = 10KΩ (°°) R <sub>g</sub> = 0		88 90		dB
SVR	Supply voltage rejection	V <sub>s</sub> = 18V R <sub>L</sub> = 4Ω f <sub>ripple</sub> = 100 Hz R <sub>g</sub> = 10KΩ	40	50		dB
T <sub>sd</sub>	Thermal shut-down junction temperature (*)			145		°C

**Note :**

- (°) Weighting filter = curve A.
- (° °) Filter with noise bandwidth: 22 Hz to 22 KHz.

Figure 1. Quiescent output voltage vs. supply voltage

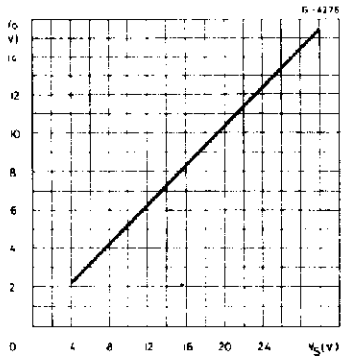


Figure 2. Quiescent drain current vs. supply voltage

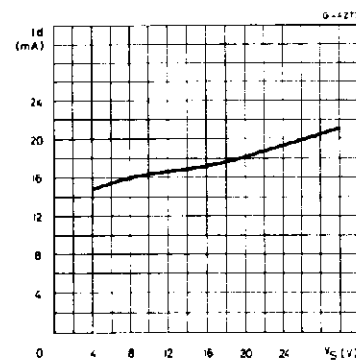


Figure 3. Output power vs. supply voltage

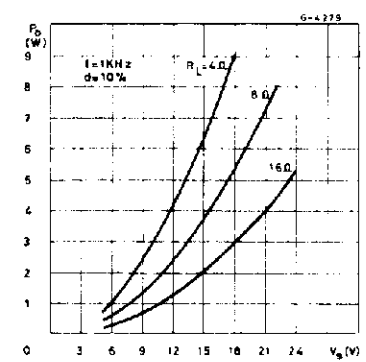


Figure 4. Distortion vs. output power ( $R_L = 16\Omega$ )

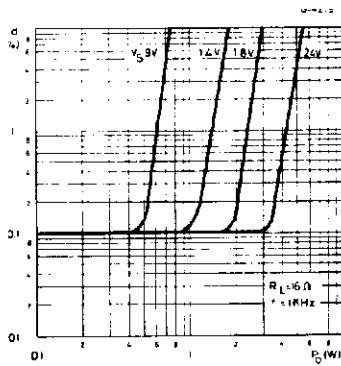


Figure 5. Distortion vs. output power ( $R_L = 8\Omega$ )

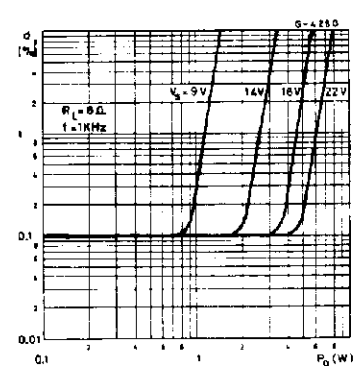


Figure 6. Distortion vs. output power ( $R_L = 4\Omega$ )

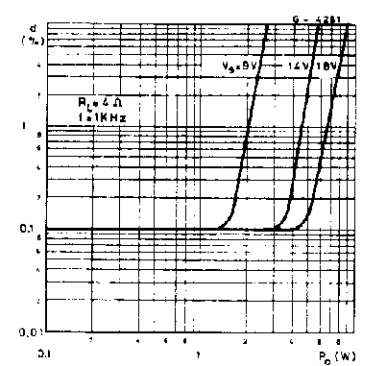


Figure 7. Distortion vs. frequency ( $R_L = 16\Omega$ )

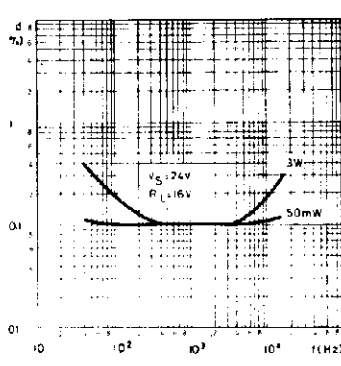


Figure 8. Distortion vs. frequency ( $R_L = 8\Omega$ )

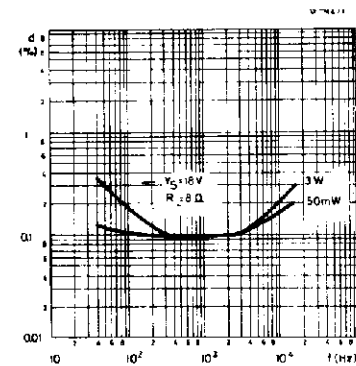


Figure 9. Distortion vs. frequency ( $R_L = 4\Omega$ )

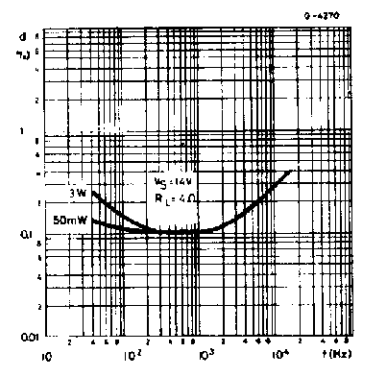


Figure 10. Open loop frequency response

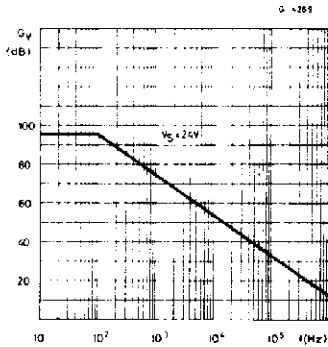


Figure 11. Output power vs. input voltage

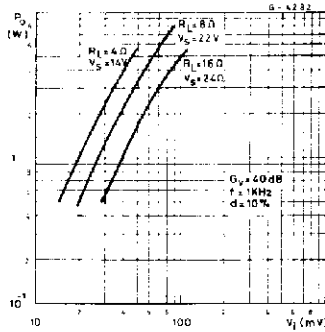


Figure 12. Values of capacitor CX versus gain and BW

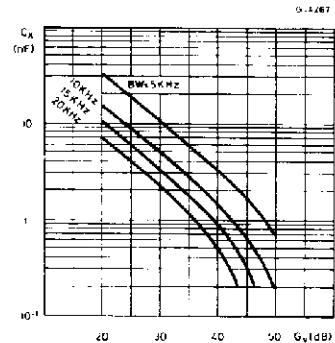


Figure 13. Supply voltage rejection vs. voltage gain

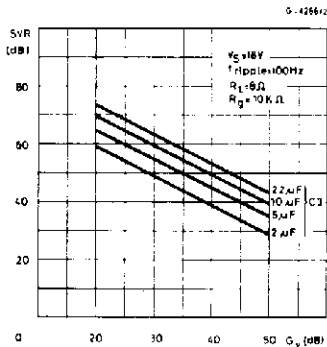


Figure 14. Supply voltage rejection vs. source resistance

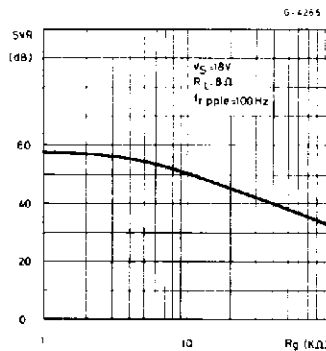


Figure 15. Max power dissipation vs. supply voltage

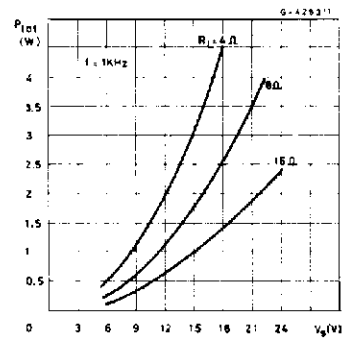


Figure 16. Power dissipation and efficiency vs. output power (Vs = 14V)

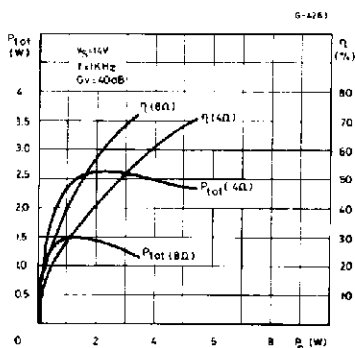


Figure 17. Power dissipation and efficiency vs. output power (Vs = 18V)

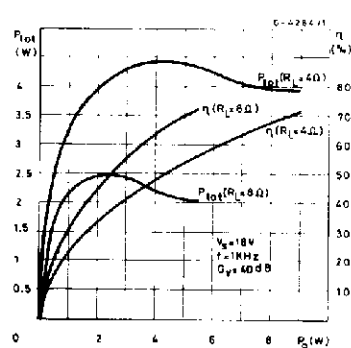
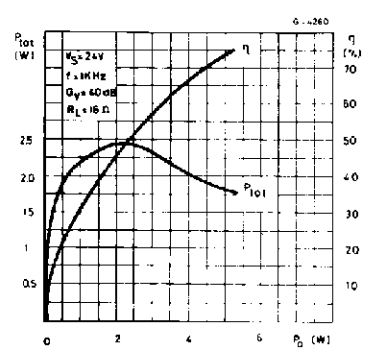


Figure 18. Power dissipation and efficiency vs. output power (Vs = 24V)



APPLICATION INFORMATION

Figure 19. Application circuit with bootstrap

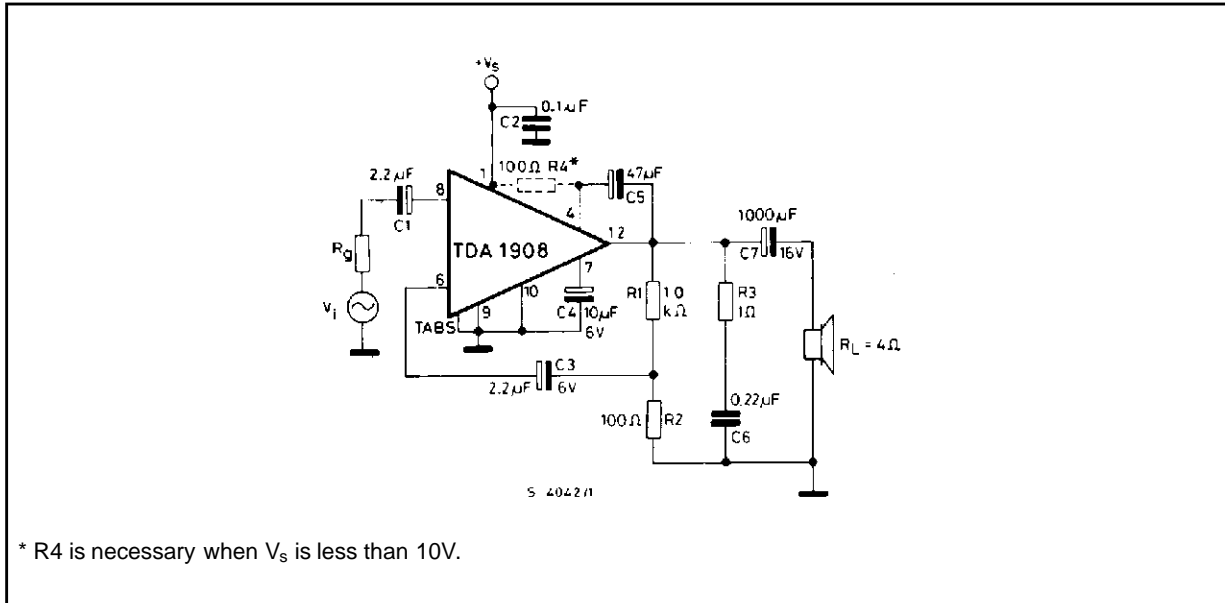
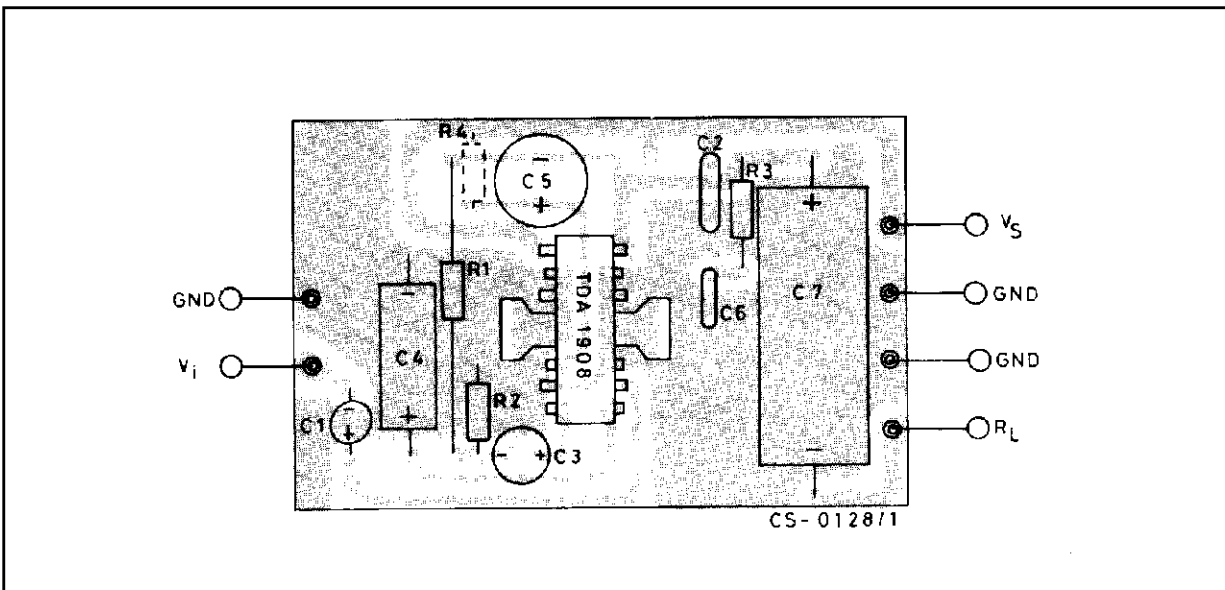


Figure 20. P.C. board and component lay-out of the circuit of fig. 19 (1 : 1 scale)



APPLICATION INFORMATION (continued)

Figure 21. Application circuit without bootstrap

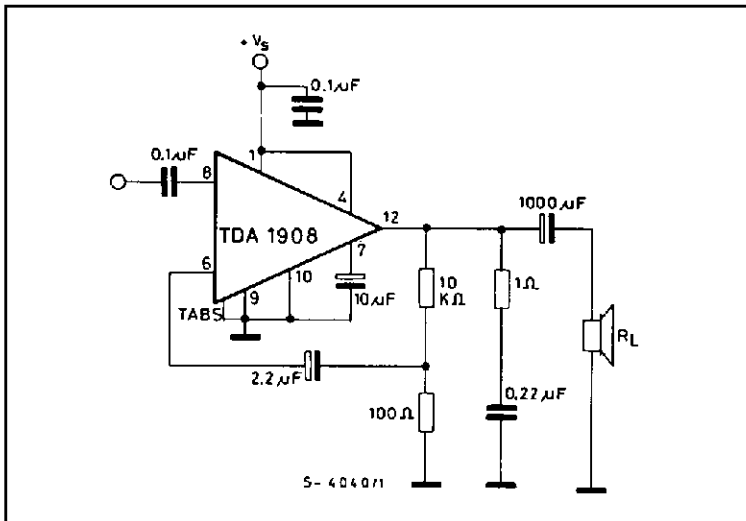


Figure 22. Output power vs. supply voltage (circuit of fig. 21)

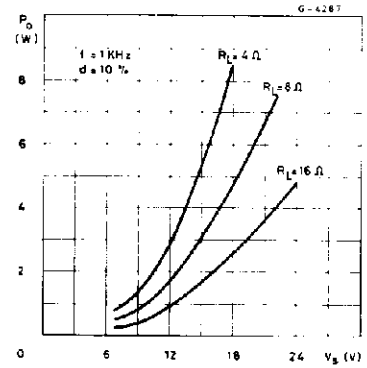
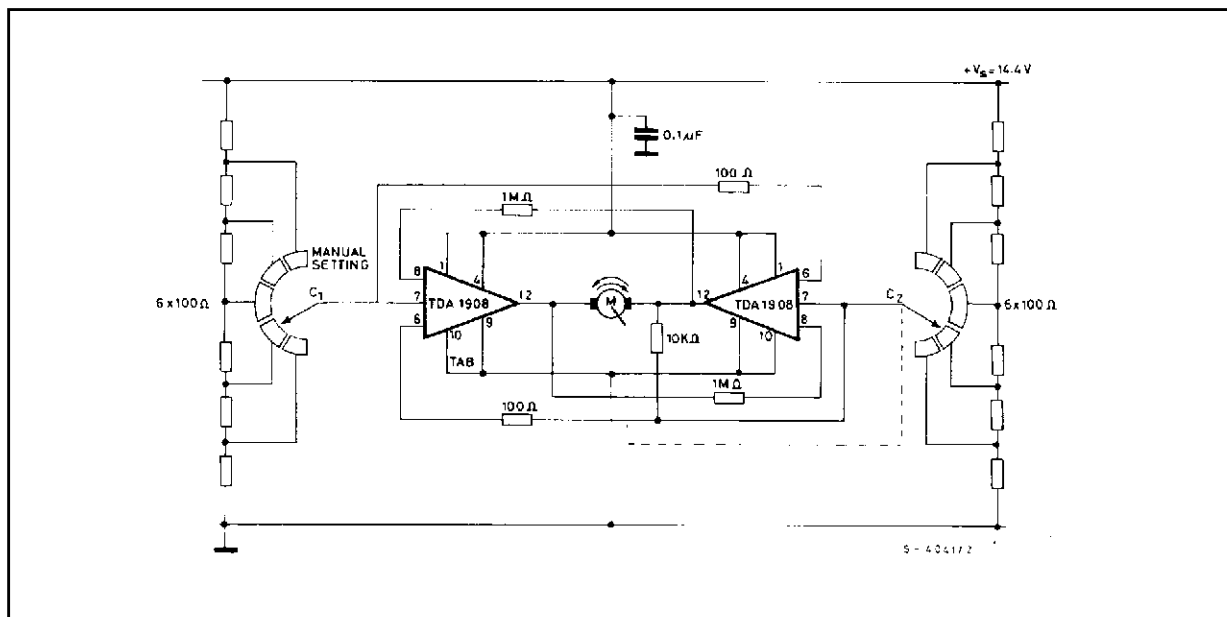


Figure 23. Position control for car headlights





## APPLICATION SUGGESTION

The recommended values of the external components are those shown on the application circuit of fig. 19. When the supply voltage  $V_s$  is less than 10V, a 100 $\Omega$  resistor must be connected between pin 1 and pin 4 in order to obtain the maximum output power.

Different values can be used. The following table can help the designer.

Component	Raccom. value	Purpose	Larger than raccomanded value	Smaller than raccomanded value	Allowed range	
					Min.	Max.
R <sub>1</sub>	10 K $\Omega$	Close loop gain setting	Increase of gain.	Decrease of gain. Increase quiescent current.	9 R <sub>2</sub>	
R <sub>2</sub>	100 $\Omega$	Close loop gain setting.	Decrease of gain.	Increase of gain.		R <sub>1</sub> /9
R <sub>3</sub>	1 $\Omega$	Frequency stability	Danger of oscillation at high frequencies with inductive loads.			
R <sub>4</sub>	100 $\Omega$	Increaseing of output swing with low $V_s$ .			47 $\Omega$	330 $\Omega$
C <sub>1</sub>	2.2 $\mu$ F	Input DC decoupling.	Lower noise.	Higher low frequency cutoff. Higher noise.	0.1 $\mu$ F	
C <sub>2</sub>	0,1 $\mu$ F	Supply voltage bypass.		Danger of oscillations.		
C <sub>3</sub>	2.2 $\mu$ F	Inverting input DC decoupling.	Increase of the switch-on noise	Higher low frequency cutoff.	0.1 $\mu$ F	
C <sub>4</sub>	10 $\mu$ F	Ripple Rejection.	Increase of SVR. Increase of the switch-on time.	Degradation of SVR.	2.2 $\mu$ F	100 $\mu$ F
C <sub>5</sub>	47 $\mu$ F	Bootstrap		Increase of the distorsion at low frequency	10 mF	100 $\mu$ F
C <sub>6</sub>	0.22 $\mu$ F	Frequency stability.		Danger of oscillation.		
C <sub>7</sub>	1000 $\mu$ F	Output DC decoupling.		Higher low frequency cutoff.		

**THERMAL SHUT-DOWN**

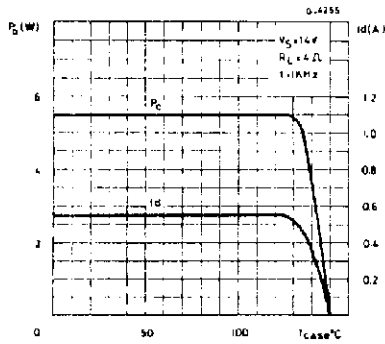
The presence of a thermal limiting circuit offers the following advantages:

- 1) An overload on the output (even if it is permanent), or an above limit ambient temperature can be easily supported since the  $T_j$  cannot be higher than  $150^{\circ}\text{C}$ .
- 2) The heatsink can have a smaller factor of safety compared with that of a conventional circuit. There is no possibility of device damage due to high junction temperature.

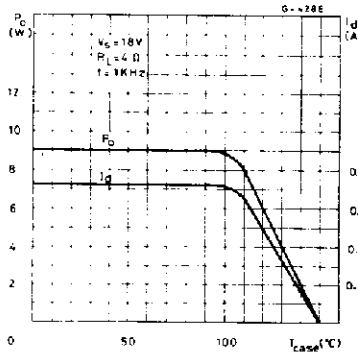
If, for any reason, the junction temperature increase up to  $150^{\circ}\text{C}$ , the thermal shut-down simply reduces the power dissipation and the current consumption.

The maximum allowable power dissipation depends upon the size of the external heatsink (i.e. its thermal resistance); fig. 25 shows the dissipable power as a function of ambient temperature for different thermal resistance.

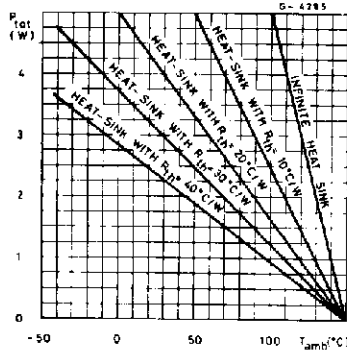
**Figure 24. Output power and drain current vs. case temperature**



**Figure 25. Output power and drain current vs. case temperature**



**Figure 26. Maximum power dissipation vs. ambient temperature**

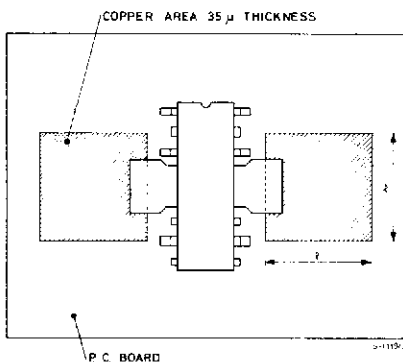


**MOUNTING INSTRUCTIONS**

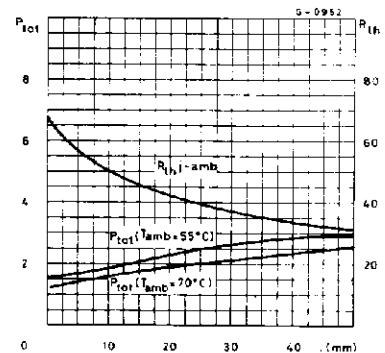
The thermal power dissipated in the circuit may be removed by soldering the tabs to a copper area on the PC board (see Fig. 27).

During soldering, tab temperature must not exceed  $260^{\circ}\text{C}$  and the soldering time must not be longer than 12 seconds.

**Figure 27. Mounting example**

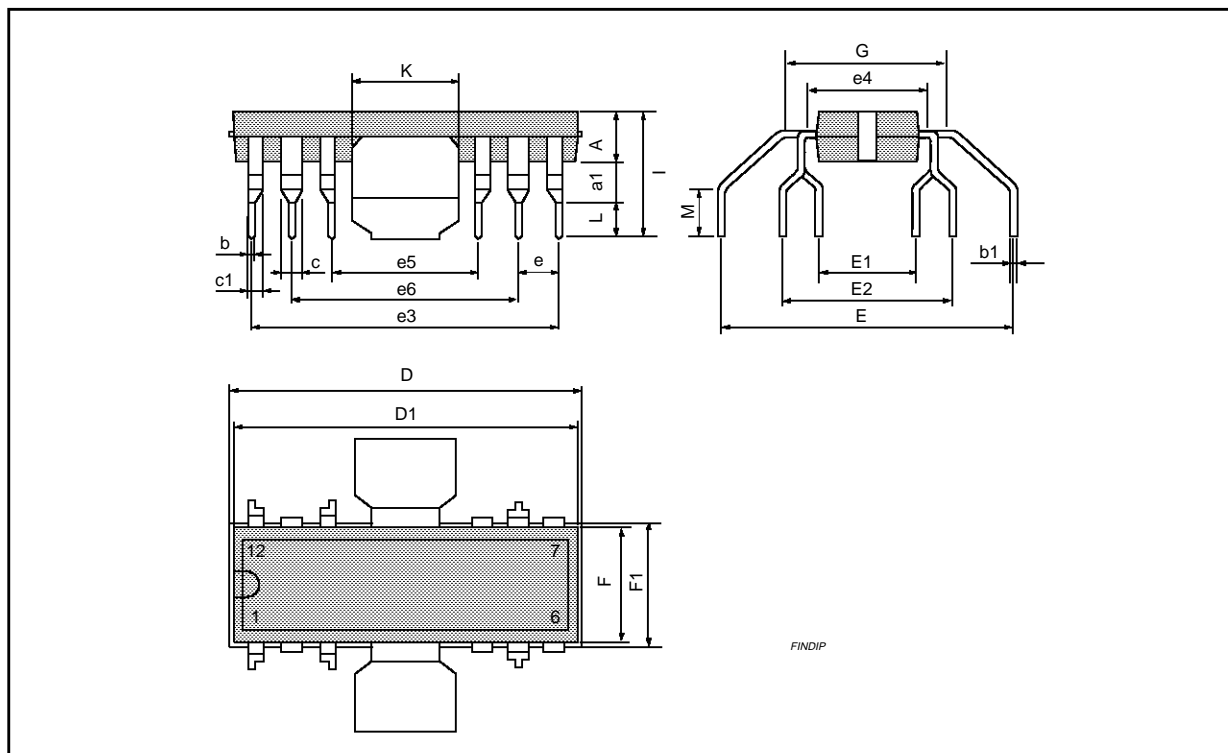


**Figure 28. Maximum power dissipation and thermal resistance vs. side "P"**



## FINDIP PACKAGE MECHANICAL DATA

DIM.	mm			inch		
	MIN.	TYP.	MAX.	MIN.	TYP.	MAX.
A	3.8		4.05	0.150		0.159
a1	1.5		1.75	0.059		0.069
b	0.55		0.6	0.022		0.024
b1	0.3		0.35	0.012		0.014
c		1.32			0.052	
c1		0.94			0.037	
D	19.2		19.9	0.756		0.783
E	16.8	17.2	17.6	0.661	0.677	0.693
E1	4.86		5.56	0.191		0.219
E2	10.11		10.81	0.398		0.426
e	2.29	2.54	2.79	0.090	0.100	0.110
e3	17.43	17.78	18.13	0.686	0.700	0.714
e4		7.62			0.300	
e5	7.27	7.62	7.97	0.286	0.300	0.314
e6	12.35	12.7	13.05	0.486	0.500	0.514
F	6.3		7.1	0.248		0.280
F1	6.1		6.7	0.240		0.264
G		9.8			0.386	
I	7.8		8.6	0.307		0.339
K	6.1		6.5	0.240		0.256
L	2.5		2.9	0.098		0.114
M	2.5		3.1	0.098		0.122



Information furnished is believed to be accurate and reliable. However, SGS-THOMSON Microelectronics assumes no responsibility for the consequences of use of such information nor for any infringement of patents or other rights of third parties which may result from its use. No license is granted by implication or otherwise under any patent or patent rights of SGS-THOMSON Microelectronics. Specifications mentioned in this publication are subject to change without notice. This publication supersedes and replaces all information previously supplied. SGS-THOMSON Microelectronics products are not authorized for use as critical components in life support devices or systems without express written approval of SGS-THOMSON Microelectronics.

© 1994 SGS-THOMSON Microelectronics - All Rights Reserved

SGS-THOMSON Microelectronics GROUP OF COMPANIES

Australia - Brazil - France - Germany - Hong Kong - Italy - Japan - Korea - Malaysia - Malta - Morocco - The Netherlands - Singapore - Spain - Sweden - Switzerland - Taiwan - Thailand - United Kingdom - U.S.A.